

ksniffer: Determining the Remote Client Perceived Response Time from Live Packet Streams

David P. Olshefski^{1,2}, Jason Nieh¹ and Erich Nahum²

¹Columbia University and ²IBM T.J Watson Research

olshef@us.ibm.com, nieh@cs.columbia.edu, nahum@us.ibm.com

Abstract

As dependence on the World Wide Web continues to grow, so does the need for businesses to have quantitative measures of the client perceived response times of their Web services. We present *ksniffer*, a kernel-based traffic monitor capable of determining pageview response times as perceived by remote clients, in real-time at gigabit traffic rates. *ksniffer* is based on novel, online mechanisms that take a “look once, then drop” approach to packet analysis to reconstruct TCP connections and learn client pageview activity. These mechanisms are designed to operate accurately with live network traffic even in the presence of packet loss and delay, and can be efficiently implemented in kernel space. This enables *ksniffer* to perform analysis that exceeds the functionality of current traffic analyzers while doing so at high bandwidth rates. *ksniffer* requires only to passively monitor network traffic and can be integrated with systems that perform server management to achieve specified response time goals. Our experimental results demonstrate that *ksniffer* can run on an inexpensive, commodity, Linux-based PC and provide online pageview response time measurements, across a wide range of operating conditions, that are within five percent of the response times measured at the client by detailed instrumentation.

1 Introduction

For many businesses, the World Wide Web is a highly competitive environment. Customers seeking quality online services have choices, and often the characteristic that distinguishes a successful site from the rest is performance. Clients are keenly aware when response time exceeds acceptable thresholds and are not hesitant to simply take their business elsewhere. It is therefore extremely important for businesses to know the response time that their clients are experiencing. This places them in a difficult position: having to obtain accurate client perceived response time metrics in a timely, cost effective manner so that problems can be immediately identified and fixed. For larger Web sites, the requirement of having a scalable solution is key; in addition, the capability to transmit this information to an online cluster management system is also a necessity.

Server farm management systems that allocate resources on-demand to meet specified response time goals are receiving much attention. The ability of a Web hosting center to move CPU cycles, machines, bandwidth and storage from a hosted Web site that is meeting its latency goal to one that is not, is a key requirement for an automated management system. Such allocation decisions must be based on accurate measurements. Over-allocating resources to one hosted Web site results in an overcharge to that customer and a reduction in the available physical resources left to meet the needs of the others. Under-allocation results in poor response time and unsatisfied Web site users. The ability to base these allocation decisions on a measure that is relevant to both the Web site owner and the end user of the Web site is a competitive advantage.

Unfortunately, obtaining an accurate measure of the client perceived response time is non-trivial. Current approaches include active probing from geographically distributed monitors, instrumenting HTML Web pages with JavaScript, offline analysis of packet traces, and instrumenting Web servers to measure application-level performance or per connection performance. All of these approaches fall short, in one area or another, in terms of accuracy, cost, scalability, usefulness of information collected, and real-time availability of measurements.

We have created *ksniffer*, an online server-side traffic monitor that combines passive packet capture with fast online mechanisms to accurately determine client perceived pageview response times on a per pageview basis. *ksniffer* uses a model of TCP retransmission and exponential backoff that accounts for latency due to connection setup overhead and network packet loss. It combines this model with higher level online mechanisms that use access history and HTTP referer information when available to learn relationships among Web objects to correlate connections and Web objects to determine pageview response times.

ksniffer mechanisms take a “look once, then drop” approach to packet analysis, use simple hashing data structures to match Web objects to pageviews, and can be efficiently implemented in kernel space. Furthermore, *ksniffer* only looks at TCP/IP and HTTP protocol header information and does not need to parse any HTTP data

payload. This enables ksniffer to perform higher level Web pageview analysis effectively online in the presence of high data rates; it can monitor traffic at gigabit line speeds while running on an inexpensive, commodity PC. These mechanisms enable ksniffer to provide accurate results across a wide range of operating conditions, including high load, connection drops, and packet loss. In these cases, obtaining accurate performance measures is most crucial because Web server and network resources may be overloaded.

ksniffer has several advantages over other approaches. First, ksniffer does not require any modifications to Web pages, Web servers, or browsers, making deployment easier and faster. This is particularly important for Web hosting companies responsible for maintaining the infrastructure surrounding a Web site but are often not permitted to modify the customer's server machines or content. Second, ksniffer captures network characteristics such as packet loss and delay, aiding in distinguishing network problems from server problems. Third, ksniffer measures the behavior of every session for every real client who visits the Web site. Therefore, it does not fall prey to biases that arise when sampling from a select, predefined set of client monitoring machines that have better connectivity, and use different Web browser software, than the actual users of the Web site. Fourth, ksniffer can obtain metrics for any Web content, not just HTML. Fifth, ksniffer performs online analysis of high bandwidth, live packet traffic instead of offline analysis of traces stored on disk, bypassing the need to manage large amounts of disk storage to store packet traces. More importantly, ksniffer can provide performance measurements to Web servers in real-time, enabling them to respond immediately to performance problems through diagnosis and resource management.

This paper presents the design and implementation of ksniffer. Section 2 presents an overview of the ksniffer architecture. Section 3 describes the ksniffer algorithms for reconstructing TCP connections and pageview activities. Section 4 discusses how ksniffer handles less ideal operating conditions, such as packet loss and server overload. Section 5 presents experimental results quantifying the accuracy and scalability of ksniffer under various operating conditions. We measure the accuracy of ksniffer against measurements obtained at the client and compare the scalability of ksniffer against user-space packet analysis systems. Section 6 discusses related work. Finally, we present some concluding remarks and directions for future work.

2 Overview of ksniffer Architecture

ksniffer is motivated by the desire to have a fast, scalable, flexible, inexpensive traffic monitor that can be used both in production environments for observing Web servers,

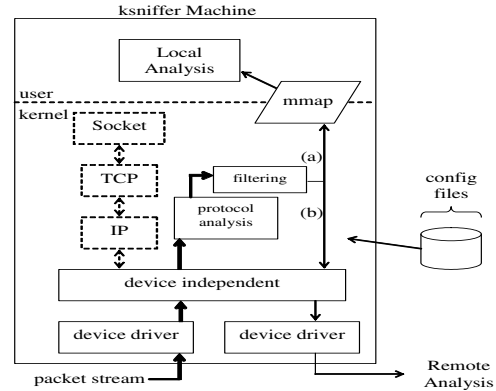

Figure 1: ksniffer architecture.

as well as a platform for research into traffic analysis. Figure 1 depicts the ksniffer architecture.

ksniffer is designed to be implemented as a set of dynamically loadable kernel modules that reside above the network device independent layer in the operating system. Its device independence makes it easy to deploy on any inexpensive, commodity PC without special NIC hardware or device driver modifications. ksniffer appears to the kernel simply as another network protocol layer within the stack and is treated no different than TCP/IP, which is shown for comparison in Figure 1. ksniffer monitors bidirectional traffic and looks at each packet once, extracts any TCP/IP or HTTP header information that is present, then discards the packet. The in-kernel implementation exploits several performance advantages such as zero-copy buffer management, eliminated system calls, and reduced context switches [16, 17]. ksniffer does not produce packet trace log files, but can read configuration parameters and write debugging information to disk from kernel space.

This design gives ksniffer a three to four fold improvement in performance over user space systems that copy every packet to user space. Each packet could potentially impact the response time measurement, yet ksniffer only examines a small percentage of the bytes within each packet (TCP/IP fields and the HTTP headers, if present). By executing in kernel space, ksniffer avoids transferring large amounts of irrelevant bytes to user space, saving CPU cycles and memory bandwidth.

ksniffer provides a low overhead shared memory interface (similar to MAGNET [13]) to export results (*not packets*) to user space. This allows more sophisticated analysis that is less performance critical to be done in user-level programs without additional system call overhead. ksniffer also provides the ability to transmit results directly to a remote machine for processing. Filtering within ksniffer is performed on the results, not on the incoming packet stream. This differentiates ksniffer from traditional monitors that exclude certain TCP flows from analysis, which affects aggregate metrics for

the Web site. A detailed discussion of how ksniffer facilitates other user-level and remote analysis is beyond the scope of this paper. The focus of this paper is on the protocol analysis portion of ksniffer shown in Figure 1, which contains the functionality for determining pageview response times. For simplicity, we assume a single Web server in our discussion, but the same ksniffer monitoring approach also applies to a Web site supported by multiple Web servers.

3 ksniffer Pageview Response Time

To determine the client perceived response time for a Web page, ksniffer measures the time from when the client sends a packet corresponding to the start of the transaction until the client receives the packet corresponding to the end of the transaction. How a packet may indicate the start or end of a transaction depends upon several factors. To show how this is done, we first briefly describe some basic entities tracked by ksniffer, then describe how ksniffer determines response time based on an anatomical view of the client/server behavior that occurs when a Web page is downloaded.

ksniffer keeps track of four entities to maintain the information it needs to measure response time: clients, pageviews, HTTP objects, and TCP connections. ksniffer tracks each of these entities using the corresponding data objects shown in Figure 2. Clients are uniquely identified by their IP address. A pageview consists of a container page and a set of embedded HTTP objects. For example, a typical Web page consists of an HTML file as the container page and a set of embedded images which are the embedded HTTP objects. Pageviews are identified by the URL of the associated container page and Web objects are identified by their URL. A flow represents a TCP connection, and is uniquely identified by the four tuple consisting of source and destination IP address and port numbers.

It is the associations between instances of these objects which enables ksniffer to reconstruct the activity at the Web site. To efficiently manage these associations, ksniffer maintains sets of hash tables to perform fast lookup and correlation between the four types of objects. Separate hash tables are used for finding clients and flows, indexed by hash functions on the IP address and four-tuple, respectively. Each client object contains a pageview hash table indexed by a hash function over the container page URL. Flows contain a FIFO request queue of Web objects that have been requested but not completed, and a FIFO finish queue of Web objects that have been completed.

Suppose a remote client, C_j , requests a Web page. We decompose the resulting client/server behavior into four parts: TCP connection setup, HTTP request, HTTP response, and embedded object processing. We use the fol-

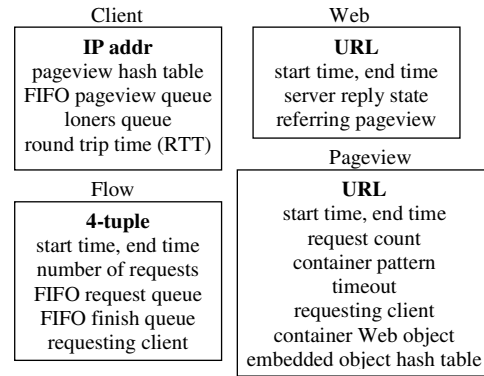

Figure 2: Objects used by ksniffer for tracking.

lowing notation in our discussion. Let C_j be the j^{th} remote client and F_i^j be the i^{th} TCP connection associated with remote client C_j . Let pv_i^j be the i^{th} pageview associated with remote client C_j , and $w_k^{j,i}$ be the k^{th} Web object requested on F_i^j . Let t_i be the i^{th} moment in time, d represent an insignificant amount of processing time, either at the client or the server, p represent the Web server processing time of an HTTP request, and RTT be the round trip time between the client and the server.

3.1 TCP Connection Setup

If the client, C_j , is not currently connected to the Web server, the pageview transaction begins with making a connection. Connection establishment is performed using the well known TCP three-way handshake, as shown in Figure 3. The start of the pageview transaction corresponds to the SYN J packet transmitted by the client at time t_0 . However, ksniffer is located on the server-side of the network, where a dotted line is used in Figure 3 to represent the point at which ksniffer captures the packet stream. ksniffer does not capture SYN J until time $t_0 + .5RTT$, after the packet takes $1/2$ RTT to traverse the network. This is assuming ksniffer and the Web server are located close enough together that they see packets at essentially the same time.

If this is the first connection from C_j , ksniffer will create a flow object F_1^j and insert it in the flow hash table. At this moment, ksniffer does not know the value for RTT since only the SYN J packet has been captured, so it cannot immediately determine time t_0 . Instead, it sets the start time for F_1^j equal to $t_0 + .5RTT$. ksniffer then waits for further activity on the connection. At $t_0 + 1.5RTT + 2d$, ksniffer and the Web server receive the ACK K+1 packet, establishing the TCP connection between client and server. ksniffer can now determine the RTT as the difference between the SYN-ACK from the server (the SYN K, ACK J+1 packet) and the resulting ACK from the client during connection establishment (the ACK K+1 packet). ksniffer then updates F_1^j 's start time by subtracting $1/2$ RTT from its value to obtain t_0 .

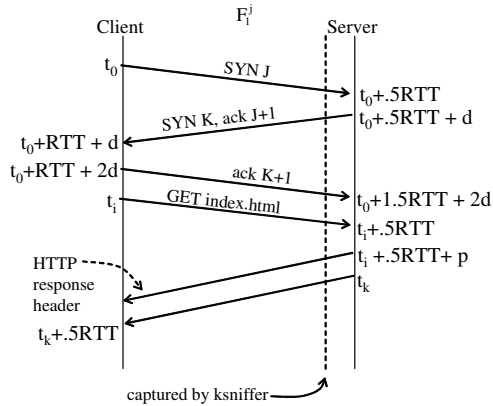

Figure 3: HTTP request/reply.

At time $t_0 + 1.5RTT + 2d$, for the first connection from C_j , ksniffer creates a client object C_j , saves the RTT value, and inserts the object into the client hash table. For each subsequent connection from C_j , a new flow object F_i^j will be created and linked to the existing client object, C_j . The RTT for each new flow will be computed, and C_j 's RTT will be updated based on an exponentially weighted moving average of the RTT s of its flows in the same manner as TCP [28]. The updated RTT is then used to determine the actual start time for each flow, t_0 .

3.2 HTTP Request

Once connected to the server, the remote client transmits an HTTP request for the container page and waits for the response. If this is not the first request over the connection, then this HTTP request indicates the beginning of the pageview transaction. Figure 3 depicts the first request over a connection. At time t_i , the client transmits the HTTP GET request onto the network, and after taking $1/2$ RTT to traverse the network, the server receives the request at $t_i + .5RTT$.

ksniffer captures and parses the packet containing the HTTP GET request, splitting the request into all its constituent components and identifying the URL requested. Since this is the first HTTP request over connection F_1^j , it incurs the connection setup overhead. In this case, a Web object is created, $w_1^{j,1}$, to represent the request, and the start time for $w_1^{j,1}$ is set to the start time of F_1^j . In this manner, the connection setup time is attributed to the first HTTP request on each flow. $w_1^{j,1}$ is then inserted into F_1^j 's request queue and F_1^j 's number-of-requests field is set to one. If this was not the first HTTP request over connection F_1^j , but was instead the k^{th} request on F_1^j , a Web object $w_k^{j,1}$ would be created but its start time would be set equal to t_i .

Next, ksniffer creates pv_1^j , the pageview object that will track the pageview, and inserts it into C_j 's pageview hash table. We assume for the moment that $w_1^{j,1}$ is a

container page; embedded objects are discussed in Section 3.5. ksniffer sets pv_1^j 's start time equal to $w_1^{j,1}$'s start time, and sets $w_1^{j,1}$ as the container Web object for pv_1^j . At this point in time, ksniffer has properly determined which pageview is being downloaded, and the correct start time of the transaction.

3.3 HTTP Response

After the Web server receives the HTTP request and takes p amount of time to process it, the server sends a reply back to the client. ksniffer captures the value of p , the server response time, which is often mistakenly cited as the client perceived response time. Server response time can underestimate the client perceived response time by more than an order of magnitude [27]. The first response packet contains the HTTP response header, along with the initial portion of the Web object being retrieved. ksniffer looks at the response headers but never parses the actual Web content returned by the server; HTML parsing would entail too much overhead to be used in an online, high bandwidth environment.

ksniffer obtains F_1^j from the flow hash table and determines the first Web object in F_1^j 's request queue is $w_1^{j,1}$, which was placed onto the queue when the request was captured. An HTTP response header does not specify the URL for which the response is for. Instead, HTTP protocol semantics dictate that, for a given connection, HTTP requests be serviced in the order they are received by the Web server. As a result, F_1^j 's FIFO request queue enables ksniffer to identify each response over a flow with the correct request object.

ksniffer updates $w_1^{j,1}$'s server reply state based on information contained in the response header. In particular, ksniffer uses the *Content-length:* and *Transfer-Encoding:* fields, if present, to determine what will be the sequence number of the last byte of data transmitted by the server for this request.

ksniffer captures each subsequent packet to identify the time of the end of the response. This is usually done by identifying the packet containing the sequence number for the last byte of the response. When the response is chunked [10], sequence number matching cannot be used. Instead, ksniffer follows the chunk chain within the response body across multiple packets to determine the packet containing the last byte of the response. For CGI responses over HTTP 1.0 which do not specify the *Content-length:* field, the server closes the connection to indicate the end of the response. In this case, ksniffer simply keeps track of the time for the last data packet before the connection is closed.

ksniffer sets $w_1^{j,1}$'s end time to the arrival time of each response packet, plus $1/2$ RTT to account for the transit time of the packet from server to client. ksniffer also sets pv_1^j 's end time to $w_1^{j,1}$'s end time. The end time will

monotonically increase until the server reply has been completed, at which point the (projected) end time will be equal to $t_k + .5RTT$, as shown in Figure 3. When ksniffer captures the last byte of the response at time t_k , $w_1^{j,1}$ is moved from F_1^j 's request queue to F_1^j 's finish queue, where it remains until either F_1^j is closed or until ksniffer determines that all segment retransmissions (if any) have been accounted for, which is discussed in Section 4.

Most Web browsers in use today serialize multiple HTTP requests over a connection such that the next HTTP request is not sent until the response for the previous request has been fully received. For these clients, there is no need for each flow object to maintain a queue of requests since there will only be one outstanding request at any given time. The purpose of ksniffer's request queue mechanism is to support HTTP pipelining, which has been adopted by a small, but potentially growing number of Web browsers. Under HTTP pipelining, a browser can send multiple HTTP requests at once, without waiting for the server to reply to each individual request. ksniffer's request queues provide support for HTTP pipelining by conforming to RFC2616 [10], which states that a server must send its responses to a set of pipelined requests in the same order that the requests are received. Since TCP is a reliable transport mechanism, requests that are pipelined from the client, in a certain order, are always received by the server in the same order. Any packet reordering that may occur in the network is handled by TCP at the server. ksniffer provides similar mechanisms to handle packet reordering so that HTTP requests are placed in F_1^j 's request queues in the correct sequence. This entails properly handling a packet that contains multiple HTTP requests as well as an HTTP request which spans packet boundaries.

At this point in time, ksniffer has properly determined $t_k + .5RTT$, the time at which the packet containing the last byte of data for $w_1^{j,1}$ was received by client C_j . If the Web page has no embedded objects then this marks the end of the pageview transaction. For example, if $w_1^{j,1}$ corresponds to a PDF file instead of an HTML file, ksniffer can determine that the transaction has completed, since a PDF file cannot have embedded objects.

If $w_1^{j,1}$ can potentially embed one or more Web objects, ksniffer cannot assume that pv_1^j has completed. Instead, it needs to determine what embedded objects will be downloaded to calculate the pageview response time. At time $t_k + .5RTT$, ksniffer cannot determine yet if requests for embedded objects are forthcoming or not. In particular, ksniffer does not parse the HTML within the container page to identify which embedded objects may be requested by the browser. Such processing is too computationally expensive for an online, high bandwidth system, and often does not even provide the necessary infor-

mation. For example, a JavaScript within the container page could download an arbitrary object that could only be detected by executing the JavaScript, not just parsing the HTML. Furthermore, HTML parsing would not indicate which embedded objects are directly downloaded from the server, since some may be obtained via caches or proxies. ksniffer instead takes a simpler approach based on waiting and observing what further HTTP requests are sent by the client, then using HTTP request header information to dynamically learn which container pages embed which objects.

3.4 Online Embedded Pattern Learning

ksniffer learns which container pages embed which objects by tracking the *Referer:* field in HTTP request headers. The *Referer:* field contained in subsequent requests is used to group embedded objects with their associated container page. Since the *Referer:* field is not always present, ksniffer develops *patterns* from those it does collect to infer embedded object relationships when requests are captured that do not contain a *Referer:* field. This technique is faster than parsing HTML, executing JavaScript, or walking the Web site with a Web crawler. In addition, it allows ksniffer to react to changes in container page composition as they are reflected in the actual client transactions.

ksniffer creates referer patterns on the fly. For each HTTP request that is captured, ksniffer parses the HTTP header and determines if the *Referer:* field is present. If so, this relationship is saved in a *pattern* for the container object. For example, when monitoring ibm.com, if a GET request for *obj1.gif* is captured, and the *Referer:* field is found to contain "www.ibm.com/index.html", ksniffer adds *obj1.gif* as an embedded object within the pattern for *index.html*. If a *Referer:* field is captured which specifies a host not being monitored by ksniffer, such as "www.xyz.com/buy.html", it is ignored.

ksniffer uses file extensions as a heuristic when building patterns. Web objects with an extension such as .ps and .pdf cannot contain embedded objects, nor can they be embedded within a page. As such, patterns are not created for them, nor are they associated with a container page. Web objects with an extension such as .gif or .jpg are usually associated with a container page, but cannot themselves embed other objects. Web objects with an extension such as .html or .htm can embed other objects or be embedded themselves. Each individual .html object has its own unique pattern, but currently an .html object is never a member of another object's pattern. This prevents cycles within the pattern structures, but results in ksniffer treating frames of .html pages as separate pageviews.

Taking this approach means that ksniffer does not need to be explicitly told which Web pages embed which ob-

jects – it learns this on its own. Patterns are persistently kept in memory using a hash table indexed by the container page URL. Each pv_i^j and container $w_k^{j,i}$ is linked to the pattern for the Web object it represents, allowing ksniffer to efficiently query the patterns associated with the set of active pageview transactions.

Since Web pages can change over time, patterns get dynamically updated, based on the client activity seen at the Web site. Therefore, a particular embedded object, *obj1.jpg*, may not belong to the pattern for container *index.html* at time t_i , and yet belong to the pattern at time $t_{i\pm k}$. Likewise, a pattern may not exist for *buy.html* at time t_i , but then be created at a later time t_{i+k} , when a request is captured. Of course, the same embedded object, *obj1.jpg*, may appear in multiple patterns, *index.html* and *buy.html*, at the same time or at different times. Since patterns are only created from client transactions, the set of patterns managed by ksniffer may be a subset of all the container pages on the Web site. This can save memory: ksniffer maintains patterns for container pages that are being downloaded, but not for those container pages on the Web site which do not get requested.

Only the *Referer*: field is used to manipulate patterns, and the embedded objects within a pattern are unordered. ksniffer places a configurable upper bound of 100 embedded objects within a pattern so as to limit storage requirements. When the limit is reached, an LRU algorithm is used for replacement, removing the embedded object which has not been linked to the container page in an HTTP request for the longest amount of time.

Each pattern typically contains a superset of those objects which the container page actually embeds. As the pattern changes, the new embedded objects get added to the pattern; but the old embedded objects only get removed from the pattern if the limit is reached. This is perfectly acceptable since ksniffer does not use patterns in a strict sense to determine, absolutely, whether or not a container page embeds a particular object.

Most Web browsers, including Internet Explorer and Mozilla, provide referer fields, but some do not and privacy proxies may remove them. To see what percentage of embedded objects have referer fields in practice, we analyzed the access log files of a popular musician resource Web site that has over 800,000 monthly visitors. The access logs covered a 15 month period from January 2003 until March 2004. 87% of HTTP requests had a referer field, indicating that a substantial portion of embedded objects may have referer fields in practice. ksniffer is specifically designed for monitoring high speed links that transmit a large number of transactions per second. In the domain of pattern generation, this is an advantage. The probability that at least one HTTP request with the *Referer*: field set for a particular container page will arrive within a given time interval is extremely high.

3.5 Embedded Object Processing

If a container page references embedded objects, the end of the transaction will be indicated by the packet containing the sequence number of the last byte of data, for the last object to complete transmission. To identify this packet, ksniffer determines which embedded object requests are related to each container page using the *Referer*: field of HTTP requests, file extension information, and the referer patterns discussed in Section 3.4.

In our example, suppose *index.html* contains references to five embedded images *obj1.gif*, *obj2.gif*, *obj3.gif*, *obj4.gif*, and *obj8.gif*. The embedded objects will be identified and processed as shown in Figure 4 (ignoring for the moment F_3^j). At time $t_k + .5RTT$, the browser parses the HTML document and identifies any embedded objects. If embedded objects are referenced within the HTML, the browser opens an additional connection, F_2^j , to the server so that multiple HTTP requests for the embedded objects can be serviced, in parallel, to reduce the overall latency of the transaction. The packet containing the sequence number of the last byte of the last embedded object to be fully transmitted indicates the end of the pageview transaction, t_e .

The start and end times for embedded object requests are determined in the same manner as previously described in Sections 3.2 and 3.3. Each embedded object that is requested is tracked in the same manner that the container page, *index.html*, was tracked. For example, when the second connection is initiated, ksniffer creates a flow object F_2^j to track the connection, and associates it with C_j . When the request for *obj1.gif* on F_2^j is captured at time t_q , a $w_1^{j,2}$ object is created for tracking the request, and is placed onto F_2^j 's request queue.

To determine the pageview response time, which is calculated as $t_e - t_0$, requires correlating embedded objects to their proper container page, which involves tackling a set of challenging problems. Clients, especially proxies, may be downloading multiple pageviews simultaneously. It is possible for a person to open two or more browsers and connect to the same Web site, or for a proxy to send multiple pageview requests to a server, on behalf of several remote clients. In either case, there can be multiple currently active pageview transactions simultaneously associated with the remote client C_j (e.g., pv_1^j , $pv_2^j \dots pv_k^j$). In addition, some embedded objects being requested may appear in multiple pageviews, and some Web objects may be retrieved from caches or CDNs. ksniffer applies a set of heuristics that attempt to determine the true container page for each embedded object. We present experimental results in Section 5 demonstrating that these heuristics are effective for accurately measuring client perceived response time.

For example, suppose that F_3^j in Figure 4 depicts

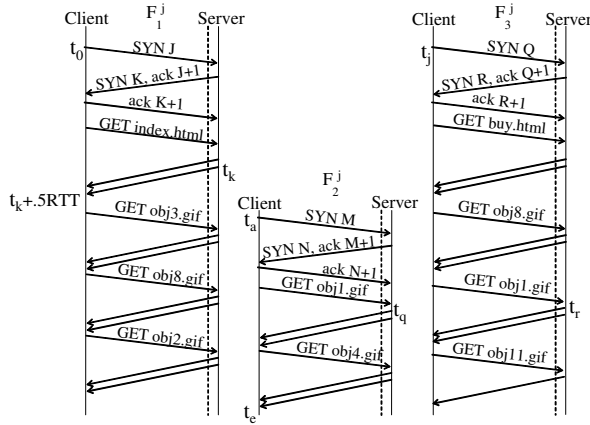

Figure 4: Downloading multiple container pages and embedded objects over multiple connections.

client C_j downloading *buy.html* at roughly the same time as *index.html* (i.e., $t_0 \approx t_j$). Suppose also that ksniffer knows in advance that *index.html* embeds $\{obj1.gif, obj3.gif, obj8.gif, obj4.gif, obj2.gif\}$ and that *buy.html* embeds $\{obj1.gif, obj8.gif, obj11.gif\}$. This means that both container pages are valid candidates for the true container page of *obj1.gif*. Whether or not $t_r < t_q$ is a crucial indication as to the true container page. At time t_a , when connection F_2^j is being established, there is no information which could distinguish whether this connection belongs to *index.html* or *buy.html*. The only difference between F_1^j , F_2^j and F_3^j with respect to the TCP/IP 4-tuple is the remote client port number. Hence only the client, C_j , can be identified at time t_a , and at time t_q , it is unknown whether *index.html* or *buy.html* is the true container page for *obj1.gif*.

To manage pageviews and their associated embedded objects, ksniffer maintains three lists of active pageviews for each client, each sorted by request time, as shown in Figure 5. The *loners queue* contains pageviews which represent objects that cannot have embedded objects. These pageviews are kept in their own list, which is never searched when attempting to locate a container page for a new embedded object request. All other pageviews, which could potentially embed an object, are placed on both a *FIFO pageview queue* and the *pageview hash table*. This enables ksniffer to quickly locate the youngest candidate container page. Each pageview also maintains an embedded object hash table, not shown in Figure 5, that consists of the embedded objects associated with that pageview and state indicating whether and to what extent they have been downloaded.

Given a request $w_i^{j,k}$ captured on flow F_k^j for client C_j , ksniffer will perform the following actions:

1. If $w_i^{j,k} \in \{.html, .shtml, \dots\}$ ksniffer will treat $w_i^{j,k}$ as a container page by placing it into the pageview hash table (and FIFO queue) for client C_j . In addition, if a pageview is currently associated with F_k^j ,

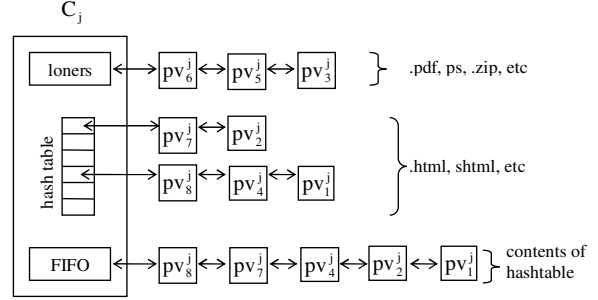

Figure 5: Client active pageviews.

2. If $w_i^{j,k} \in \{.pdf, .ps, \dots\}$ ksniffer will treat $w_i^{j,k}$ as a loner object by placing it on the loner queue for C_j . In addition, if a pageview is currently associated with F_k^j , ksniffer assumes it is done.
3. If $w_i^{j,k} \in \{.jpg, .gif, \dots\}$ then
 - (a) If the *Referer:* field contains the monitored server name, such as *www.ibm.com/buy.html*, then C_j 's pageview hash table is searched to locate pv_c^j , the youngest pageview downloading that container page (*buy.html*) that has yet to download $w_i^{j,k}$. If pv_c^j exists, $w_i^{j,k}$ is associated to pv_c^j as one of its embedded objects. If no pageview meets the criterion, pv_c^j is created and $w_i^{j,k}$ is associated to it.
 - (b) If the *Referer:* field contains a foreign host name, such as *www.xyz.com/buy.html*, then $w_i^{j,k}$ is treated as a loner object.
 - (c) If $w_i^{j,k}$ has no *Referer:* field, then the FIFO queue is searched to locate, pv_c^j , the youngest pageview which has $w_i^{j,k}$ in its referer pattern and has yet to download $w_i^{j,k}$. If pv_c^j exists, then $w_i^{j,k}$ is associated to pv_c^j as one of its embedded objects. If no pageview meets the criterion, then $w_i^{j,k}$ is treated as a loner object.

The algorithm above is based on several premises. If a request for an embedded object $w_i^{j,k}$ arrives with a referer field containing the monitored server as the host (e.g., *www.ibm.com/buy.html*), then the remote browser almost certainly must have previously downloaded that container page (e.g., *buy.html*) from the monitored server (e.g., *www.ibm.com*), parsed the page, and is now sending the request for the embedded object $w_i^{j,k}$. If ksniffer failed to capture the request for the container page (e.g., *buy.html*) it is highly likely that it is being served from the browser cache for this particular transaction. If a request for an embedded object arrives with a referer field containing a foreign host (e.g., *www.xyz.com/buy.html*), it is highly likely that the foreign host is simply embedding objects from the monitored Web site into its own pages.

When a request for an embedded object arrives with-

out a referer field, every pageview associated with the client becomes a potential candidate for the container page of that object. This is depicted in Figure 4 when the request for *obj1.gif* arrives without a *Referer:* field. If the client is actually a remote proxy, then the number of potential candidates may be large. ksniffer applies the patterns described in Section 3.4 as a means of reducing the number of potential candidates and focusing on the true container page of the embedded object. The heuristic is to locate the youngest pageview which contains the object in its pattern, but has yet to download the object. Patterns are therefore exclusionary. Any candidate pageview not containing the embedded object in its pattern is excluded from consideration. This may result in the true container page being passed over, but as mentioned in Section 3.4, the likelihood that a container page embeds an object that does not appear in the page's pattern is very low for an active Web site. If a suitable container pageview is not found, then the object is treated as a loner object. If a *Referer:* field is missing, then most likely it was removed by a proxy and not a browser on the client machine; but if the proxy had cached the container page during a prior transaction, it is likely to have cached the embedded object as well. This implies the object is not being requested as part of a page, but being downloaded as an individual loner object.

If a client downloads an embedded object, such as *obj1.gif*, it is unlikely that the client will download the same object again, for the same container page. If an object appears multiple places within a container page, most browsers will only request it once from the server. Therefore, ksniffer not only checks if an embedded object is in the pattern for a container page, but also checks if that instance has already downloaded the object or not.

The youngest candidate is usually a better choice than the oldest candidate. If browsers could not obtain objects from a cache or CDN, then the oldest candidate would be a better choice, based on FCFS. Since this is not the case choosing the oldest candidate will tend to assign an object *obj1.jpg* to a container page whose 'slot' for *obj1.jpg* was already filled via an unseen cache hit. This tends to overestimate response time for older pages. It is more likely that an older page obtained *obj1.jpg* from a cache and that the younger page is the true container for *obj1.jpg*, than vice versa.

ksniffer relies on capturing the last byte of data for the last embedded object to determine the pageview response time. However, given the use of browser caches and CDNs, not all embedded objects will be seen by ksniffer since not all objects will be downloaded directly from the Web server. The purpose of a cache or CDN is to provide much faster response time than can be delivered by the original Web server. As a result, it is likely that objects requested from a cache or CDN will be received by the

client before objects requested from the original server. If the Web server is still serving the last embedded object received by the client, other objects served from a cache or CDN will not impact ksniffer's pageview response time measurement accuracy. If the last embedded object received by the client is from a cache or CDN, ksniffer will end up not including that object's download time as part of its pageview response time. Since caches and CDNs are designed to be fast, the time unaccounted for by ksniffer will tend to be small even in this case.

Given that embedded objects may be obtained from someplace other than the server, and that a pattern for a container page may not be complete, how can ksniffer determine that the last embedded object has been requested? For example, at time t_e , how can ksniffer determine whether the entire download for *index.html* is completed, or another embedded object will be downloaded for *index.html* on either F_1^j or F_2^j ? This is essentially the same problem described at the end of Section 3.3 with respect to whether or not a embedded objects requests will follow a request for a container page or not.

ksniffer approaches this problem in two ways. First, if no embedded objects are associated to a pageview after a timeout interval, the pageview transaction is assumed to be complete. A six second timeout is used by default, in part based on the fact that the current ad hoc industry quality goal for complete Web page download times is six seconds [19]. If a client does not generate additional requests for embedded objects within this time frame, it is very likely that the pageview is complete. ksniffer also cannot report the response time for a pageview until the timeout expires. A six second timeout is small enough to impose only a modest delay in reporting.

Second, if a request for a container page, $w_k^{j,i}$, arrives on a persistent connection F_i^j , then we consider that all pageview transactions associated with each prior object, $w_b^{j,i}$, $b < k$, on F_i^j to be complete. In other words, a new container page request over a persistent connection signals the completion of the prior transaction and the beginning of a new one. We believe this to be a reasonable assumption, including under pipelined requests, since in most cases, only the embedded object requests will be pipelined. Typical user behavior will end up serializing container page requests over any given connection. Hence, the arrival of a new container page request would indicate a user click in the browser associated with this connection. Taking this approach also allows ksniffer to properly handle quick clicks, when the user clicks on a visible link before the entire pageview is downloaded and displayed in the browser.

4 Packet Loss

Studies have shown that the packet loss rate within the Internet is roughly 1-3% [34]. We classify packet loss

into three types: A) a packet is dropped by the network before being captured by ksniffer, B) a packet is dropped by the network after being captured and C) a packet is dropped by the server or client after being captured. Types A and B are most often due to network congestion or transmission errors while type C drops occur when the Web server (or, less likely, the client) becomes temporarily overloaded. The impact that a packet drop has on measuring response time depends not only on where or why it was dropped, but also on the contents of the packet. We first address the impact of SYN drops, then look at how a lost data packet can affect response time measurements.

Figure 3 depicts the well known TCP connection establishment protocol. Suppose that the initial SYN which is transmitted at time t_0 is either dropped in the network or at the server. In either case, no SYN/ACK response is forthcoming from the server. The client side TCP recognizes such SYN drops through use of a timer [27]. If a response is not received in 3 seconds, TCP will retransmit the SYN packet. If that SYN packet is also dropped by the network or server, TCP will again resend the same SYN packet, but not until after waiting an additional 6 seconds. As each SYN is dropped, TCP doubles the wait period between SYN retransmissions: 3 s, 6 s, 12 s, 24 s, etc. TCP continues in this manner until either the configured limit of retries is reached, at which time TCP reports “unable to connect” back to the browser, or the user takes an action to abort the connection attempt, such as refreshing or closing the browser.

This additional delay has a large impact on the client response time. Suppose there is a 3% network packet loss rate from client to server. Three percent of the SYN packets sent from the remote clients will be dropped in the network before reaching ksniffer or the server. The problem is that since the SYN packets are dropped in the network before reaching the server farm, both ksniffer and the server are completely unaware that the SYNs were dropped. This will automatically result in an error for any traffic monitoring system which measures response time using only those packets which are actually captured. If each client is using two persistent connections to access the Web site, this error will be 180% for a 100 ms response time and a 4.5% error for a 4s response time. Under HTTP 1.0 without Keep-Alive, where a connection is opened to obtain each object, the probability of a network SYN drop grows with the number of objects in the pageview. For a page download of 10 objects, there is a 30% chance of incurring the 3 second retransmission delay, a 60% chance for 20 objects and a 90% chance for 30 objects.

ksniffer uses a simple technique for capturing this undetectable connection delay (type ‘A’ SYN packet loss). Three counters are kept for each subnet. One of the three

counters is incremented whenever a SYN/ACK packet is retransmitted from the server to the client (which indicates that the SYN/ACK packet was lost in the network). The counter that gets incremented depends on how many times the SYN/ACK has been transmitted. Every time a SYN/ACK is sent twice, the first counter is incremented, every time a SYN/ACK packet is sent 3 times, the second counter is incremented, and every time a SYN/ACK is sent 4 times, the third counter is incremented. Whenever a SYN packet arrives for a new connection, if one of the three counters is greater than zero, then ksniffer subtracts the appropriate amount of time from the start time of the connection and decrements the counter (round robin is used to break ties). Assuming that a SYN packet will be dropped as often as a SYN/ACK, this gives ksniffer a reasonable estimate for the number of connections which are experiencing a 3 s, 9 s, or 21 s connection delay.

The same retransmission delays are incurred when SYNs are dropped by the server (type ‘C’). In this case, ksniffer is able to capture and detect that the SYNs were dropped by the server, and distinguish these connection delays, which are due to server overload, from those previously described, which are due to network congestion. ksniffer also determines when a client is unable to connect to the server. If the client reattempts access to the Web site in the next six seconds after a connection failure, ksniffer considers the time associated with the first failed connection attempt as part of the connection latency for the reattempt; otherwise the failed connection attempt is reported under the category “frustrated client”.

Similar undetected latency occurs when a GET request is dropped in the network before reaching ksniffer or the server, then retransmitted by the client. An undetected GET request drop differs from an undetected SYN drop in two ways. First, unlike SYN drops, TCP determines the retransmission timeout period based on RTT and a number of implementation dependent parameters. ksniffer implements the standard RTO calculation [28] using Linux TCP parameters, and adjusts for this undetectable time in the same manner as mentioned above. Second, a dropped GET request will only affect the measurement of the overall pageview response time if the GET request is for a container page and is not the first request over the connection. Otherwise, the start of the transaction will be indicated by the start of connection establishment, not the time of the container page request.

As mentioned earlier, ksniffer often expects to capture the packet containing the sequence number of the last byte of data for a particular request. To capture retransmissions, ksniffer uses a timer along with the finish queue on each flow to capture retransmitted packets and update the end of response time appropriately. Suppose the last packet of a response is captured by ksniffer at time t_k , at which point ksniffer identifies it as containing

the sequence number for the last byte of the response, and moves the $w_k^{j,i}$ request object from the flow's request queue to the flow's finish queue. The packet is then dropped in the network before reaching the client (type 'B'). At time t_{k+h} , ksniffer will capture the retransmitted packet and, using its sequence number, determine that it is a retransmission for $w_k^{j,i}$, which is located on the finish queue. The completion time of $w_k^{j,i}$ is then set to the timestamp of this packet.

5 Experimental Results

We implemented ksniffer as a set of Linux kernel modules and installed it on a commodity PC to demonstrate its accuracy and performance under a wide range of Web workloads. We report an evaluation of ksniffer in a controlled experimental setting as well as an evaluation of ksniffer tracking user behavior at a live Internet Web site.

Our experimental testbed is shown in Figure 6. We used a traffic model based on Surge [3] but made some minor adjustments to reflect more recent work [14, 31] done on characterizing Web traffic: the maximum number of embedded objects in a given page was reduced from 150 to 100 and the percentage of base, embedded, and loner objects were changed from 30%, 38% and 32% to 42%, 48% and 10%, respectively. The total number of container pages was 1041, with 959 unique embedded objects. 49% of the embedded objects are embedded by more than one container page. We also fixed a bug in the modeling code and included CGI scripts in our experiments, something not present in Surge.

For traffic generation, we used an updated version of WaspClient [25], which is a modified version of the client provided by Surge. Virtual clients on each machine cycle through a series of pageview requests, first obtaining the container page then all its embedded objects. A virtual client can open 2 parallel TCP connections for fetching pages, mimicking the behavior of Microsoft IE. Requests on a TCP connection are serialized, so that the next request is not sent until the current response on that connection is obtained. In addition, each virtual client binds to a unique IP address using IP aliasing on the client machine. This lets each client machine appear to the server as a collection of up to 200 unique clients from the same subnet.

To emulate wide-area conditions, we extended the rshaper [30] bandwidth shaping tool to include packet loss and round trip latencies. We installed this software on each client traffic generator machine, enabling us to impose packet drops as well as the RTT delays between 20 to 200 ms as specified in Figure 6.

To quantify the accuracy of the client perceived response times measured by ksniffer, we ran fifteen different experiments with different traffic loads under non-ideal and high-stress operating conditions and compared

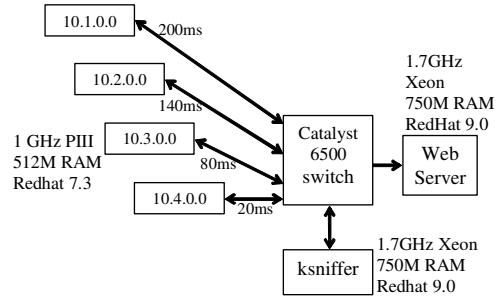

Figure 6: Experimental environment.

ksniffer's measurements against those obtained by the traffic generators executing on the client machines. We measured with two different Web servers, Apache and TUX, used both HTTP 1.0 without Keep-Alive and persistent HTTP 1.1, and included a combination of static pages and CGI programs for Web content. We also measured in the presence of network and server packet loss, missing referer fields, client caching, and near gigabit traffic rates. Table 1 summarizes these experimental results. In all cases, the difference between the mean response time as determined by ksniffer, and that measured directly on the remote client was less than 5%. Furthermore, the absolute time difference between ksniffer and client-side instrumentation was in some cases less than 1 ms and in all cases less than 50 ms.

All tests (except Tests S1 and S2) were done under non-ideal conditions found in the Internet with 2% packet loss and 20% missing referer fields. Each client requested the same sequence of pageviews, but since each traffic generator machine was configured with a different RTT to the Web server as shown in Figure 6, the clients took different amounts of time to obtain all of their pages, resulting in a variable load on the Web server over time. For example, Figure 7 shows results from Test F comparing ksniffer against client-side instrumentation in measuring pageviews/s over time. There are two lines in the figure, but they are hard to distinguish because ksniffer's pageview count is so close to direct client-side instrumentation. Figure 8 shows results from Test F comparing ksniffer against client-side instrumentation in measuring mean client perceived pageview response time for each 1 second interval. ksniffer results are very accurate and hard to distinguish from client-side instrumentation. As indicated by Figure 7, the variable response time is due to the completion of clients. During the initial 250 s, clients from each of the four subnets are actively making requests. At around 250 s, the clients from subnet 10.4.0.0 with RTT 20 ms have completed, while clients from the other subnets remain active. At around 300 s, the clients from subnet 10.3.0.0 with RTT of 80 ms have completed, leaving clients from subnets 10.2.0.0 and 10.1.0.0 active. At time 475 s, clients from subnet 10.2.0.0 with RTT of 140 ms have completed, leaving only those clients from subnet 10.1.0.0 with RTT

	Virtual Clients	Web Server	HTTP	PV/s	URL/s	Mbps	Client RT	ksniffer RT	diff (ms)	% diff	elapsed time
A	120	Apache	1.0	5-140	5-625	1-60	1.528s	1.498s	-29	-1.9	133m
B	120	Apache	1.0	5-160	10-660	1-60	1.513s	1.483s	-30	-2.0	133m
C	120	Apache	1.1	10-180	30-730	3-70	1.003s	0.981s	-22	-2.2	79m
D	120	Apache	1.1	10-400	40-1520	3-140	0.726s	0.699s	-27	-3.7	72m
E	800	TUX	1.0	65-750	260-3000	15-270	1.556s	1.506s	-49	-3.2	20m
F	800	TUX	1.1	125-1370	500-5300	35-455	0.815s	0.782s	-33	-4.1	11m
G	500	Apache	1.0	35-500	140-2000	10-200	1.537s	1.489s	-48	-3.1	32m
H	400	Apache	1.1	60-690	250-2880	15-250	0.792s	0.825s	-33	-4.0	22m
I	500	Apache	1.1	60-700	260-3000	20-265	0.884s	0.929s	-45	-4.8	18m
S1	16	TUX	1.0	1909	8,007	690	7.8ms	7.7ms	-0.17	-2.2	210s
S2	80	TUX	1.1	2423	10,164	878	30.5ms	29.7ms	-0.83	-2.7	165s
V	800	TUX	1.0	0-2410	0-10,000	0-850	0.574s	0.571s	-3	-0.5	29m
O1	800	Apache	1.0	419	1756	152	1.849s	1.806s	-42	-2.3	16m
O2	240	Apache	1.1	728	3054	264	.328s	.318s	-10	-3.1	9m
X	800	Apache	1.0	2174	9120	462	.365s	.363s	-1.7	-0.5	184s

Table 1: Summary of results.

subnets	RTT (ms)	Client RT	ksniffer RT	diff (ms)	% diff	ksniffer RTT(ms)
10.1.0.0	200	1.424s	1.391s	-33	-2.3	199.8
10.2.0.0	140	1.099s	1.073s	-26	-2.4	139.8
10.3.0.0	80	0.824s	0.806s	-18	-2.3	79.7
10.4.0.0	20	0.666s	0.656s	-10	-1.6	19.9

Table 2: Mean RT per subnet, Test C.

of 200 ms. Note that, although the pageview request rate decreases, the mean response time increases because the remaining clients have larger RTTs to the Web server and thus incur larger response times.

Table 2 shows results for Test C obtained by implementing a longest prefix matching algorithm based on [5] in ksniffer to categorize RTT and response time on a per subnet basis. These results show that ksniffer provides accurate pageview response times as compared to client-side instrumentation even on a per subnet basis when different subnets have different RTTs to the Web server. ksniffer RTT measurements are also very accurate as compared to the actual RTT used for each subnet. The results show how this mechanism can be very effective in differentiating performance and identifying problems across different subnets.

Tests S1 and S2 were done under high bandwidth conditions to show results at the maximum bandwidth rate possible in our testbed. This was done by using the faster TUX Web server and by imposing no packet loss or network delay. For HTTP 1.1, 80 virtual clients generated the greatest bandwidth rate, but under HTTP 1.0 only 16 clients generated the highest bandwidth rate. ksniffer is within 3% of client-side measurements, even under rates of 690 Mbps and 878 Mbps of HTTP content. The absolute time difference between ksniffer and client response time measurements was less than 1 ms. We note that the

resolution of the packet timer on ksniffer is only 1 ms, due to the Linux clock timer granularity. Under HTTP 1.0 without Keep-Alive, each object retrieved requires its own TCP connection. The TCP connection rate under Test S1 was 8,000 connections/s. The results demonstrate ksniffer's ability to track TCP connection establishment and termination at high connection rates.

Test V was done with severe variations in load alternating between no load and maximum bandwidth load by switching the clients between on and off modes every 50 s. Figure 9 compares ksniffer response time with that measured at the client, and Figure 10 compares the distribution of the response time. This indicates ksniffer's accuracy under extreme variations in load.

Tests O1 and O2 were done with the Web server experiencing overload and therefore dropping connections. We configured Apache to support up to 255 simultaneous connections, then started 240 virtual clients. Since each client opens two connections to the server to obtain a container page and its embedded objects, this overwhelmed Apache. During Test O1 and O2, the Web server machine reported a connection failure rate of 27% and 12%, respectively. Table 1 shows that ksniffer's pageview response time for these tests were only 3% less than those from the client-side. These results show ksniffer's ability to measure response times accurately in the presence of both server overload and network packet loss

Test X was done to show ksniffer performance with caching clients by modifying the clients so that 50% of the embedded objects requested were obtained from a zero latency local cache. Figure 11 compares ksniffer and client-side instrumentation in measuring pageview response time over the course of the experiment. The results show that ksniffer can provide very accurate response time measurements in the presence of client

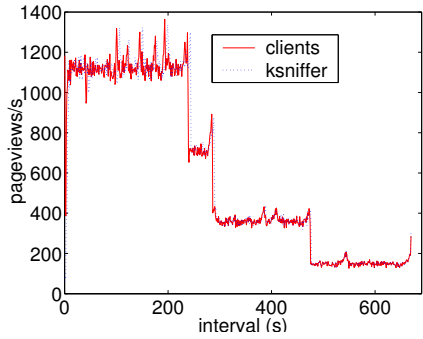

Figure 7: Test F, pageviews.

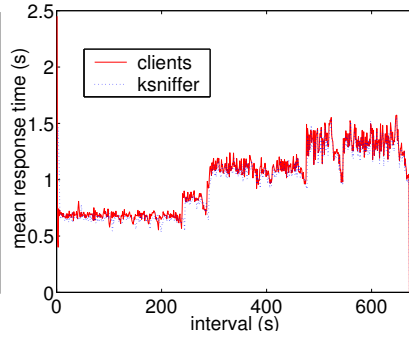

Figure 8: Test F, response time.

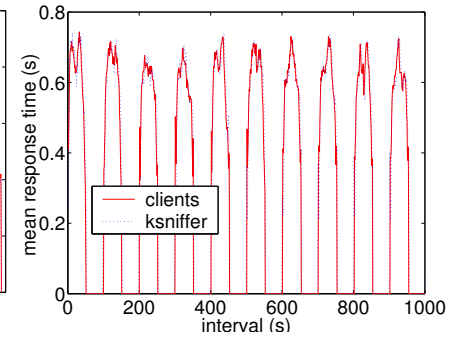

Figure 9: Test V, response time.

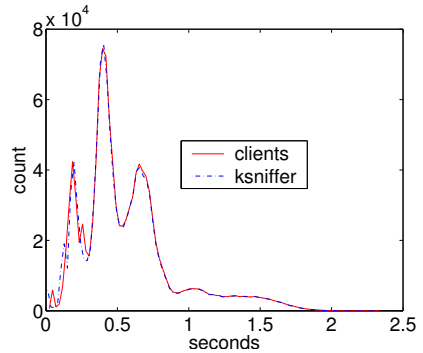

Figure 10: Test V, RT distribution.

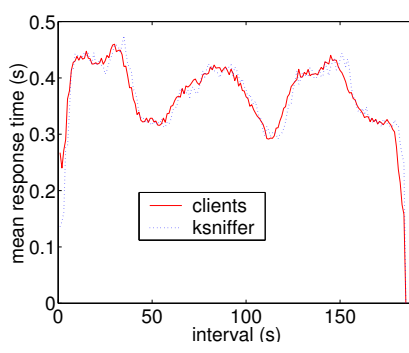

Figure 11: Text X, response time.

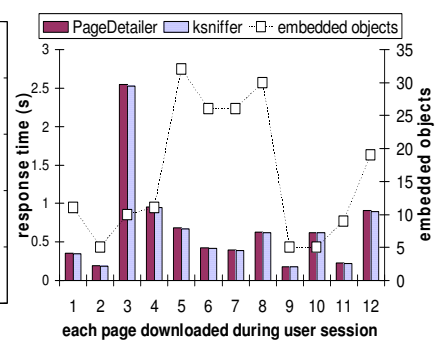

Figure 12: Live Internet Web site.

caching as well.

We deployed ksniffer in front of a live Internet Web site, GuitarNotes.com, which is hosted in NYC. Figure 12 depicts results for tracking a single user during a logon session from Hawthorne, NY. Using MS IE V6, and beginning with an empty browser cache, the user first accessed the home page and then visited a dozen pages within the site including the product review section, discussion forum, FAQ, classified ads, and performed several site searches for information. This covered a range of static and dynamically generated pageviews. The number of embedded objects for each page varied between 5 and 30, and is indicated by the dotted line, which is graphed against the secondary Y axis on the right. These objects included .gif, .css and .js objects.

PageDetailer [15] was executing on the client machine monitoring all socket level activity of IE. PageDetailer uses a Windows socket probe to monitor and timestamp each socket call made by the browser: connect(), select(), read() and write(). By parsing the HTTP requests and replies, it is able to determine the response time for a pageview, as well as for each embedded object within a page. The pageview response time is calculated as the difference between the connect() system call entry and the return from the read() system call for the last byte of data of the last embedded object. As shown in Figure 12, the response time which ksniffer calculates in NYC at the Web server is nearly identical to that measured by PageDetailer running on the remote client machine. For each of the twelve pages downloaded by the client,

ksniffer is within 5% of the response time recorded by PageDetailer.

ksniffer provides excellent performance scalability compared to common user-space passive packet capture systems. Almost all existing passive packet capture systems in use today are based on libpcap [33]. Libpcap is a user space library that opens a raw socket to provide packets to user space monitor programs. As a scalability test, we wrote a libpcap based traffic monitor program whose only function was to count TCP packets. Executing on the same physical machine as ksniffer, the libpcap packet counter program began to drop a large percentage of packets when the traffic rate was roughly 325 Mbps. In contrast, ksniffer performs complex pageview analysis at near gigabit traffic rates without such packet loss.

6 Related Work

There are a number of approaches currently being taken to address the problem of obtaining response time in the context of Web services. A number of companies [8, 20, 24, 32] provide active probing of a Web site by periodically measuring response times at a geographically distributed set of monitors. There are several limitations with this approach. First, no real Web traffic by the actual clients is measured; only the response time for transactions generated by the monitors are reported. Second, any approach based on coarsed-grained sampling may suffer from statistical biases. Third, monitors are limited to performing transactions that do not affect other users or modify state in backend databases. For exam-

ple, it would be unwise to configure a monitor to actually purchase an airline ticket or trade stock on an open exchange. Fourth, the information gathered by monitors is generally not available at the Web server in real-time, limiting the ability of a Web server to respond to changes in response time to meet delay bound guarantees. Lastly, CDN providers are known to place servers near monitors used by these companies to artificially improve their own performance measurements [7].

A second approach involves instrumenting Web pages with client-side scripting that gathers client response time statistics [29]. This approach can be used to track actual client transactions. However, client-side scripting is a ‘post-connection’ approach and therefore does not account for delays due to TCP connection setup or waiting in kernel queues on the Web server, which can be significant when network and server resources are overloaded. Client-side scripting cannot be applied to non-HTML files that cannot be instrumented, such as PDF and Postscript files. It may also not work for older browsers or browsers with scripting capabilities disabled, such as mobile devices. Client browser measurements cannot accurately decompose the response time into server and network components, providing no insight into whether server or network providers are responsible for problems.

A third approach requires the Web server to track when requests arrive and complete service, either at the application-level [2, 18, 21, 22] or at the kernel-level [27]. This approach has the desirable properties that it only requires information available at the Web server and can be used for non-HTML content. However, application-level approaches do not account for network interactions or delays due to TCP connection setup or waiting in kernel queues on the Web server. Previous results demonstrate that application-level Web server measurements can under estimate response time by more than an order of magnitude [27]. Two of the authors of this paper previously developed Certes [27], a kernel-level approach that accounts for TCP connection setup time and time spent waiting in kernel queues in measuring response time at a per connection level. ksniffer extends this work by measuring response time per pageview without any modifications to the Web server.

A fourth approach is to simply log network packets to disk, and then use the log files to reconstruct the client response time [1, 4, 9, 11, 12]. This kind of analysis is performed offline, using multiple passes and limited to analyzing only reasonably sized log files [31]. ksniffer’s correlation algorithm differs from EtE [11] in that it does not require multiple passes and offline operation, uses file extensions and refer host names in addition to the filename in the refer field, handles multiple requests for the same Web page from the same client, and accounts

for connection setup time and packet loss in determining response time. [9] describes many of the issues involved in TCP/HTTP reconstruction, but does not consider the problem of measuring response time.

Other approaches exist which can provide mechanisms for filtering and analyzing packet traces online, such as GigaScope [6], Nprobe [12], NetQoS [26], libpcap [33], and BPF [23]. However, these systems do not provide any higher-level functionality to determine pageview response times from live Web traffic. Most of this work has focused on improving packet filtering performance, which is not particularly applicable when all traffic into and out of a Web server is of interest, rather than a narrow subset.

Note that ksniffer shares certain limitations that are present in all network traffic monitors. Response time components due to processing on the remote client machines cannot be directly measured from server-side network traffic. Examples include times for DNS query resolution and HTML parsing and rendering on the client. Embedded objects obtained from locations other than the monitored servers may have an impact on accuracy as well, but only if their download completion time exceeds that of the last object obtained from the monitored server.

7 Conclusions and Future Work

We have designed, implemented and evaluated ksniffer, a kernel-based traffic monitor that can be colocated with Web servers to measure their performance as perceived by remote clients in real-time. As a passive network monitor, ksniffer requires no changes to clients or Web servers, and does not perturb performance in the way that intrusive instrumentation methods can. ksniffer determines client perceived pageview response times using novel, online mechanisms that take a “look once, then drop” approach to packet analysis to reconstruct TCP connections and learn client pageview activity.

We have implemented ksniffer as a set of loadable Linux kernel modules and validated its performance using both a controlled experimental testbed and a live Internet Web site. Our results show that ksniffer’s in-kernel design scales much better than common user-space approaches, enabling ksniffer to monitor gigabit traffic rates using only commodity hardware, software, and network interface cards. More importantly, our results demonstrate ksniffer’s unique ability to accurately measure client perceived response times even in the presence of network and server packet loss, missing HTTP referer fields, client caching, and widely varying static and dynamic Web content.

Future work includes integrating ksniffer with a cluster management system and developing mechanisms that manage resources to achieve specified response time goals. Such a management system would base resource

allocation decisions on the response time as perceived by the remote client instead of the response time as reported by other means. This may raise some interesting scheduling and allocation problems, particularly in the context of resource constrained Web sites. We expect to combine machine learning techniques with models of TCP/IP and client behavior to achieve our goals.

8 Acknowledgements

This work was supported in part by NSF grants ANI-0117738 and ANI-0240525 and an IBM SUR Award. Our thanks to Srinu Seshan for his help with the rshaper traffic tool, and to Gong Su for sharing his system expertise.

References

- [1] M. K. Aguilera et al. Performance Debugging for Distributed Systems of Black Boxes. In *SOSP '03*, p. 74–89, Lake George, NY, October 2003.
- [2] J. Almeida, M. Dabu, A. Manikutty, and P. Cao. Providing Differentiated Levels of Service in Web Content Hosting. In *Workshop on Internet Server Performance (WISP)*, Madison, WI, 1997.
- [3] P. Barford and M. Crovella. Generating Representative Web Workloads for Network and Server Performance Evaluation. In *ACM SIGMETRICS*, p. 151–160, Madison, WI, November 1998.
- [4] R. Caceres et al. Measurement and Analysis of IP Network Usage and Behavior. *IEEE Communications Magazine*, 38(5), May 2000.
- [5] T. Chiueh and P. Pradhan. High Performance IP Routing Table Lookup using CPU Caching. In *IEEE INFOCOMM*, v 3, p. 1421–1428, 1999.
- [6] C. Cranor et al. Gigascope: A Fast and Flexible Network Monitor. Technical Report TD-5ABQY6, AT&T Labs–Research, Floram Park, NJ, May 2002.
- [7] P. Danzig. Ideas for Next Generation Content Delivery. In *NOSSDAV 2001*, http://www.nosssdav.org/2001/keynote_nosssdav2001.ppt, Port Jefferson, NY, June 2001. ACM.
- [8] Exodus. <http://www.exodus.com/>.
- [9] A. Feldmann. BLT: Bi-layer Tracing of HTTP and TCP/IP. In *WWW-9*, p. 321–335, May 2000.
- [10] R. Fielding et al. Hypertext Transfer Protocol HTTP 1.1. In *IETF RFC 2616*. June 1999.
- [11] Y. Fu, L. Cherkasova, W. Tang, and A. Vahdat. EtE: Passive End-to-End Internet Service Performance Monitoring. In *USENIX 2002*, p. 115–130, Monterey, CA, June 2002.
- [12] J. Hall, I. Pratt, and I. Leslie. Non-intrusive Estimation of Web Server Delays. In *Proceedings of the IEEE Conference on Local Computer Networks (LCN)*, Tampa, Florida, November 2001.
- [13] J. Hay, W. Feng, , and M. Gardner. Capturing Network Traffic with a MAGNeT. In *5th Annual Linux Showcase and Conference (ALS)*, p. 61–70, Oakland, California, November 2001.
- [14] F. Hernandez-Campos, K. Jeffay, and F. D. Smith. Tracking the Evolution of Web Traffic: 1995-2003. In *MASCOTS 2003*, p. 16–25, Orlando, FL, October 2003.
- [15] IBM AlphaWorks. *Page Detailer*, <http://www.alphaworks.ibm.com/tech/pagedetailer>.
- [16] P. Joubert et al. High-Performance Memory-Based Web Servers: Kernel and User-Space Performance. In *USENIX 2001*, p. 175–188, Boston, MA, June 2001.
- [17] M. F. Kaashoek et al. Application Performance and Flexibility on Exokernel Systems. In *SOSP*, Saint-Malo, France, Oct. 1997.
- [18] V. Kanodia and E. Knightly. Multi-Class Latency-Bounded Web Services. In *IEEE/IFIP IWQoS*, Pittsburgh, PA, June 2000.
- [19] T. Keeley. Thin, High Performance Computing over the Internet. In *MASCOTS 2000*, p. 407, San Francisco, CA, Aug. 2000.
- [20] KeyNote. <http://www.keynote.com>.
- [21] K. Li and S. Jamin. A Measurement-Based Admission-Controlled Web Server. In *IEEE INFOCOMM*, p. 651–659, New York, NY, June 2002.
- [22] C. Lu, T. Abdelzaher, J. Stankovic, and S. H. Son. A Feedback Control Approach for Guaranteeing Relative Delays in Web Server. In *7th IEEE Real-Time Technology and Applications Symposium*, p. 51–62, Taipei, Taiwan, June 2001.
- [23] S. McCanne and V. Jacobson. The BSD Packet Filter: A new Architecture for User-Level Packet Capture. In *USENIX 1993*, p. 259–270, 1993.
- [24] Mercury Interactive. <http://www-heva.mercuryinteractive.com>.
- [25] E. Nahum, M. Rosu, S. Seshan, and J. Almeida. The Effects of Wide-Area Conditions on WWW Server Performance. In *ACM SIGMETRICS*, p. 257–267, Cambridge, MA, June 2001.
- [26] NetQoS. <http://www.NetQoS.com>.
- [27] D. Olshefski, J. Nieh, and D. Agrawal. Using Certes to Infer Client Response Time at the Web Server. *ACM Transactions on Computing Systems*, February 2004.
- [28] V. Paxson and M. Allman. Computing TCP's Retransmission Time. In *IETF RFC 2988*. November 2000.
- [29] R. Rajamony and M. Elnozahy. Measuring Client-Perceived Response Times on the WWW. In *Proceedings of the 3rd USENIX Symposium on Internet Technologies and Systems (USITS)*, San Francisco, CA, March 2001.
- [30] A. Rubini. rshaper. <http://www.linux.it/~rubini/software/index.html>.
- [31] F. D. Smith, F. H. Campos, K. Jeffay, and D. Ott. What TCP/IP Protocol Headers can tell us about the Web. In *ACM SIGMETRICS*, p. 245–256, Cambridge, MA, June 2001.
- [32] StreamCheck. <http://www.streamcheck.com>.
- [33] The libpcap project. <http://sourceforge.net/projects/libpcap>.
- [34] Y. Zhang, N. Duffield, V. Paxson, and S. Shenker. On the Constancy of Internet Path Properties. In *In Proceedings of ACM SIGCOMM Internet Measurement Workshop (IMW)*, San Francisco, CA, November 2001.